



# SF2293E

## 1561 MHz SAW Filter

- Low Loss RF SAW Filter
- Surface Mount 3.0 x 3.0 mm Package
- Complies with Directive 2002/95/EC (RoHS) 

### Absolute Maximum Ratings

Rating	Value	Units
Input Power Level	10	dBm
DC Voltage on any Non-ground Terminal	3	V
Operating Temperature Range	-40 to +70	°C
Storage Temperature Range in Tape and Reel	-40 to +85	°C
Suitable for Lead-free Soldering - Maximum Soldering Profile	260°C for 30 s	

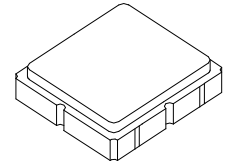

SM3030-6

### Electrical Characteristics

Characteristic	Sym	Notes	Min	Typ	Max	Units
Center Frequency	$f_C$			1561		MHz
Insertion Loss, 1550.5 to 1571.5 MHz	IL			3.3	4.0	dB
Amplitude Ripple, 1550.5 to 1571.5 MHz				0.5	2.0	
Input/Output VSWR, 1550.5 to 1571.5 MHz				1.5:1	2:1	
Attenuation, Referenced to 0 dB:						dB
$f_C - 500$ to $f_C - 100$ MHz			45	49		
$f_C - 100$ to $f_C - 60$ MHz			40	45		
$f_C - 60$ to $f_C - 40$ MHz			20	32.5		
$f_C + 40$ to $f_C + 60$ MHz			20	26		
$f_C + 60$ to $f_C + 80$ MHz			35	43		
$f_C + 80$ to $f_C + 500$ MHz			45	50		
Source Impedance	$Z_S$			50		$\Omega$
Load Impedance	$Z_L$			50		
Case Style	SM3030-6 3.0 x 3.0 mm Nominal Footprint					
Lid Symbolization (Y=year, WW=week, S=shift) dot=pin 1 indicator	A45, YWWS					
Standard Reel Quantity	Reel Size 7 Inch					500 Pieces/Reel
	Reel Size 13 Inch					3000 Pieces/Reel

### Electrical Connections

Connection	Terminals
Input	2
Output	5
Case Ground	All others

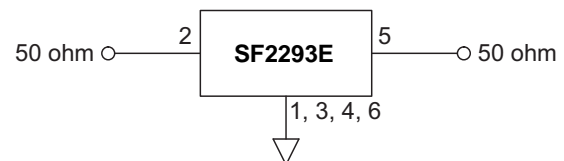

**CAUTION: Electrostatic Sensitive Device. Observe precautions for handling.**

#### Notes:

1. Unless noted otherwise, all specifications apply over the operating temperature range with filter soldered to the specified demonstration board with impedance matching to 50  $\Omega$  and measured with 50  $\Omega$  network analyzer.
2. Unless noted otherwise, all frequency specifications are referenced to the nominal center frequency,  $f_C$ .
3. Rejection is measured as attenuation below the minimum IL point in the passband. Rejection in final user application is dependent on PCB layout and external impedance matching design. See Application Note No. 42 for details.
4. "LRIP" or "L" after the part number indicates "low rate initial production" and "ENG" or "E" indicates "engineering prototypes."
5. The design, manufacturing process, and specifications of this filter are subject to change.
6. Either Port 1 or Port 2 may be used for either input or output in the design. However, impedances and impedance matching may vary between Port 1 and Port 2, so that the filter must always be installed in one direction per the circuit design.
7. US and international patents may apply.
8. RFM, stylized RFM logo, and RF Monolithics, Inc. are registered trademarks of RF Monolithics, Inc.

## Filter Response Plots

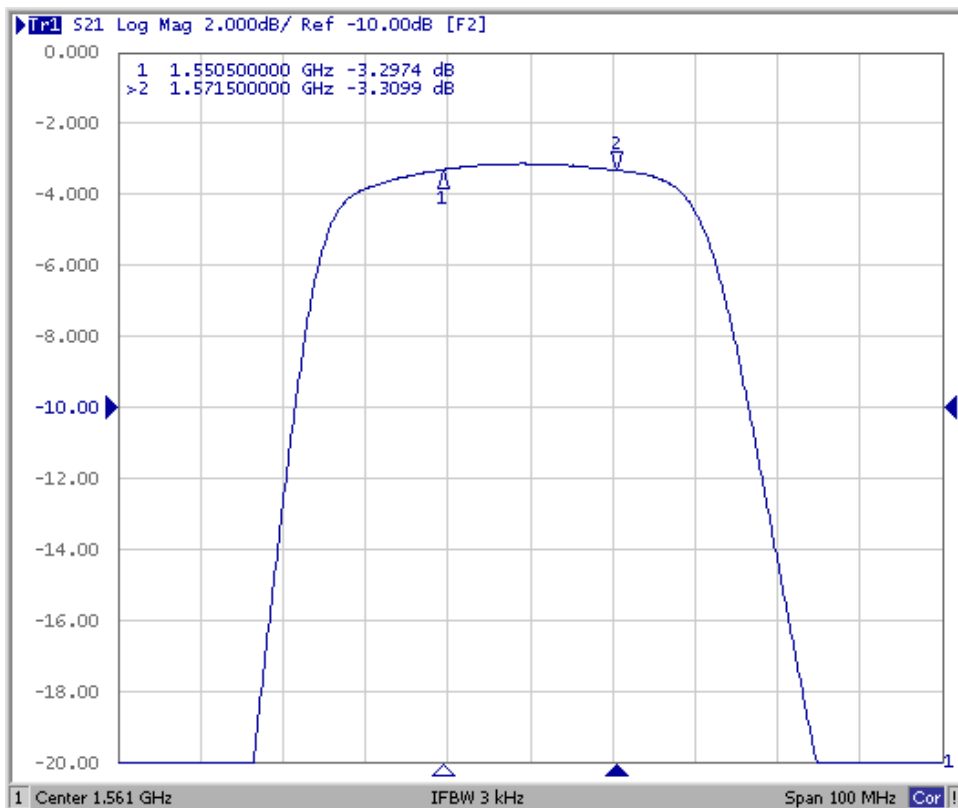
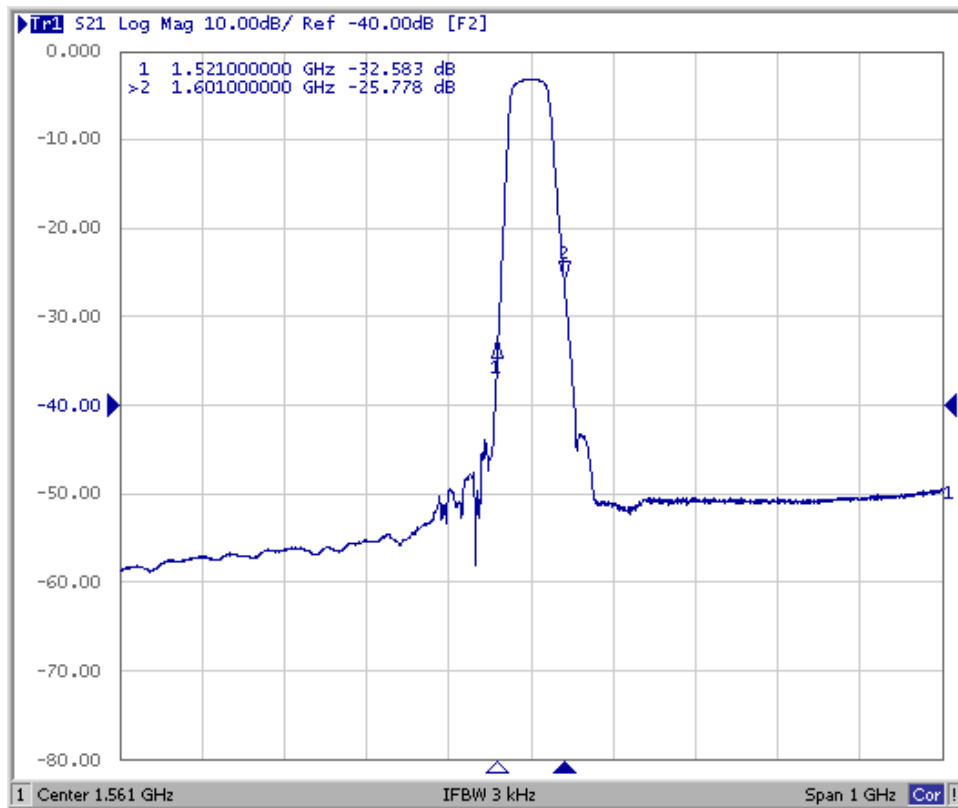

# Filter VSWR Plots

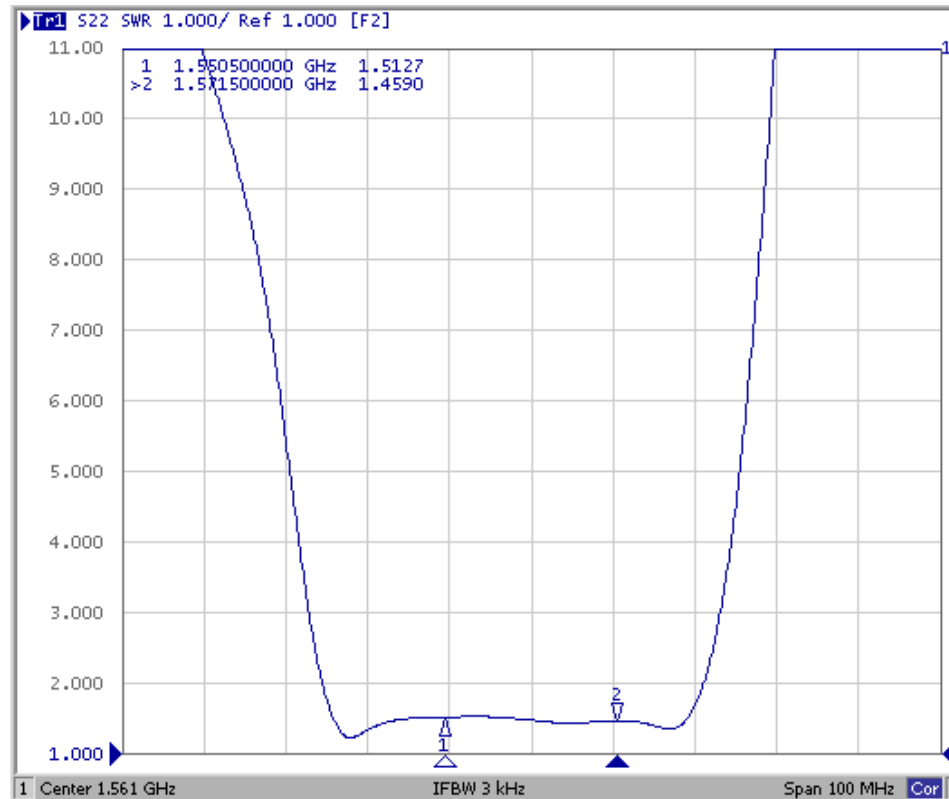
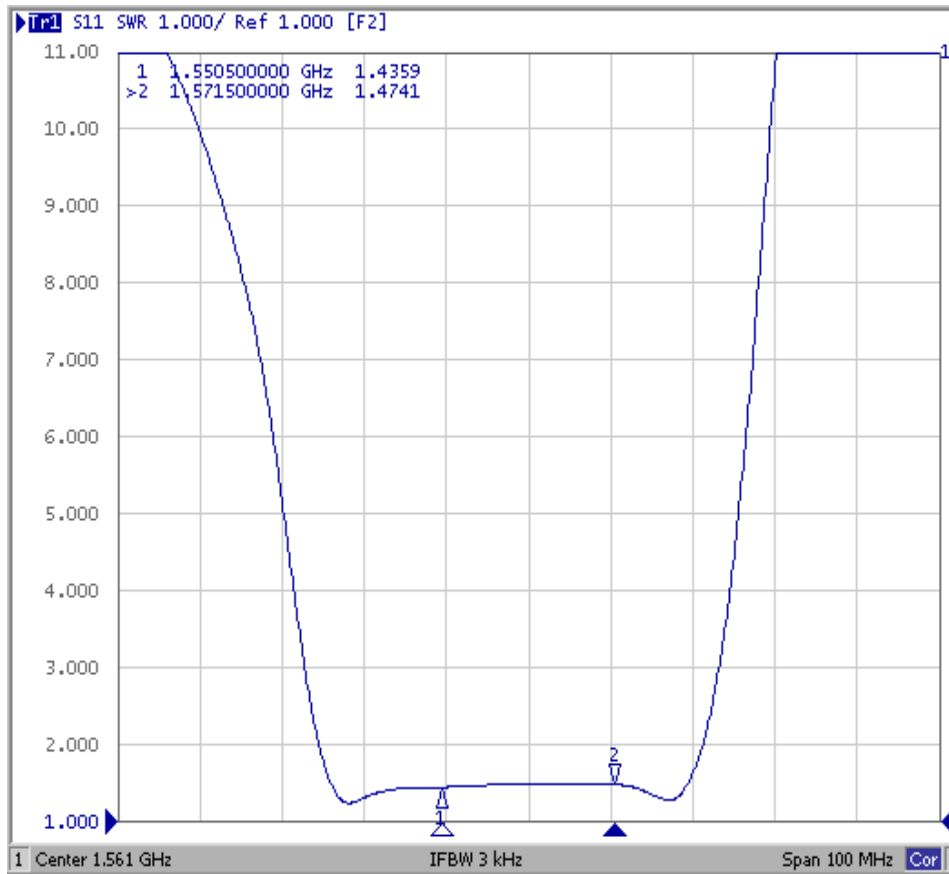

# SM3030-6 Case

## 6-Terminal Ceramic Surface-Mount Case 3.0 X 3.0 mm Nominal Footprint

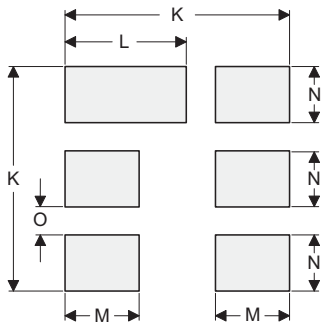
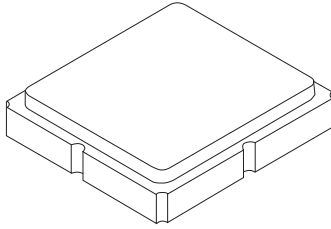

PCB Footprint Top View

### Case and PCB Footprint Dimensions

Dimension	mm			Inches		
	Min	Nom	Max	Min	Nom	Max
A	2.87	3.00	3.13	0.113	0.118	0.123
B	2.87	3.00	3.13	0.113	0.118	0.123
C	1.12	1.25	1.38	0.044	0.049	0.054
D	0.77	0.90	1.03	0.030	0.035	0.040
E	2.67	2.80	2.93	0.105	0.110	0.115
F	1.47	1.60	1.73	0.058	0.063	0.068
G	0.72	0.85	0.98	0.028	0.033	0.038
H	1.37	1.50	1.63	0.054	0.059	0.064
I	0.47	0.60	0.73	0.019	0.024	0.029
J	1.17	1.30	1.43	0.046	0.051	0.056
K		3.20			0.126	
L		1.70			0.067	
M		1.05			0.041	
N		0.81			0.032	
O		0.38			0.015	

### Case Materials

Materials	
Solder Pad Plating	0.3 to 1.0 $\mu\text{m}$ Gold over 1.27 to 8.89 $\mu\text{m}$ Nickel
Lid Plating	2.0 to 3.0 $\mu\text{m}$ Nickel
Body	$\text{Al}_2\text{O}_3$ Ceramic
Pb Free	

### TOP VIEW

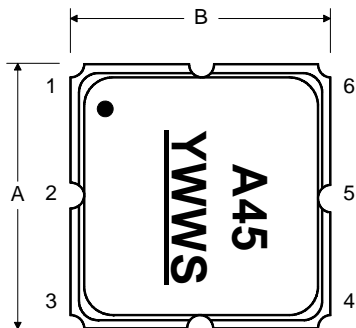

### BOTTOM VIEW

