

# SEM2410 /X /D /DX

Wireless Ethernet Bridge



## User's Guide



# Important Regulatory Information

Cirronet Product FCC ID: HSW-2410  
IC 4492A-2410

---

**Note:** This unit has been tested and found to comply with the limits for a Class A digital device, pursuant to part 15 of the FCC Rules. These limits are designed to provide reasonable protection against harmful interference when the equipment is operated in a commercial environment. This equipment generates, uses, and can radiate radio frequency energy and, if not installed and used in accordance with the instruction manual, may cause harmful interference to radio communications. Operation of this equipment in a residential area is likely to cause harmful interference in which case the user will be required to correct the interference at their expense.

---

## FCC s MPE Requirements

**Information to user/installer regarding FCC s Maximum Permissible Exposure (MPE) limits.**

**Notice to users/installers using the 24 dBi parabolic dish antenna in conjunction with all Cirronet RF products.**

FCC rules limit the use of this antenna, when connected to Cirronet RF products for **point-to-point applications only**. It is the responsibility of the installer to ensure that the system is prohibited from being used in point-to-multipoint applications, omni-directional applications, and applications where there are multiple co-located intentional radiators transmitting the same information. Any other mode of operation using this antenna is forbidden.

**Notice to users/installers using the following fixed antennas, with Cirronet RF products:**

<p>Andrews 24dBi parabolic dish Andrews 18dBi parabolic dish Cushcraft 15dBi Yagi, Mobile Mark 14dBi Corner Reflector, Mobile Mark 9dBi Corner Reflector</p>	<p>The field strength radiated by any one of these antennas, when connected to Cirronet RF products, may exceed FCC mandated RF exposure limits. FCC rules require professional installation of these antennas in such a way that the general public will not be closer than 2 m from the radiating aperture of any of these antennas. End users of these systems must also be informed that RF exposure limits may be exceeded if personnel come closer than 2 m to the apertures of any of these antennas.</p>
--	--

**Notice to users/installers using the following mobile antennas, with Cirronet RF products:**

<p>Mobile Mark 12dBi omni-directional, Mobile Mark 9dBi omni-directional, MaxRad 5dBi whip, Cirronet Patch antenna, Ace 2dBi dipole, Mobile Mark 2dBi Stub</p>	<p>The field strength radiated by any one of these antennas, when connected to Cirronet RF products, may exceed FCC mandated RF exposure limits. FCC rules require professional installation of these antennas in such a way that the general public will not be closer than 20 cm from the radiating aperture of any of these antennas. End users of these systems must also be informed that RF exposure limits may be exceeded if personnel come closer than 20 cm to the apertures of any of these antennas.</p>
--	--

# Declaration of Conformity



Warning! The RLAN transceiver within this device uses a band of frequencies that are not completely harmonized within the European Community. Before using, please read the European Operation Section of the Products User's Guide for limitations.

0889 is the identification number of RADIO FREQUENCY INVESTIGATION LTD - Ewhurst Park, Ramsdell RG26 5RQ Basingstoke, United Kingdom – the Notified Body having performed part or all of the conformity assessment on the product.

The WIT2410 to which this declaration relates is in conformity with the essential requirements of the R&TTE directive 1999/5/EC and complies with the following standards and/or other normative documents:

## For Interfaces

EN 55022

EN 55024

## For RLAN Transceiver

EN 300 328

EN 301 489 -1, -17

EN 60950

## Use Within the European Union

The WIT2410 is intended for use within the European Community States and in the following non-European Union States: Norway & Switzerland

## Use of the WIT2410 in France

When used in France, the WIT2410 can only be operated with the France hopping pattern selected. This is accomplished by setting the **pe** parameter to 1. Refer to *European Union Settings* in this manual for details.

## Canadian Department of Communications Industry Canada (IC) Notice

Canadian Department of Communications Industry Canada (IC) Notice

This apparatus complies with Health Canada's Safety Code 6 / IC RSS 102.

"To prevent radio interference to the licensed service, this device is intended to be operated indoors and away from windows to provide maximum shielding. Equipment (or its transmit antenna) that is installed outdoors may be subject to licensing."

## ICES-003

This digital apparatus does not exceed the Class B limits for radio noise emissions from digital apparatus as set out in the radio interference regulations of Industry Canada.

Le présent appareil numérique n'émet pas de bruits radioélectriques dépassant les limites applicables aux appareils numériques de Classe B prescrites dans le règlement sur le brouillage radioélectrique édicté par Industrie Canada.



## Table of Contents

Introduction .....	1
Getting Started.....	2
SEM2410, SEM2410D.....	3
Connectors .....	4
Status Indicators.....	4
SEM2410X/DX.....	6
Attaching the Remote Radio Connector – SEM2410X.....	8
Attaching Remote Radio Connector – SEM2410DX .....	9
Connectors .....	10
Status Indicators.....	11
Configuring the SEM.....	12
Setting IP Addresses .....	12
IP Hunter Utility.....	12
HTML Setup.....	15
Console Port.....	18
Filtering.....	19
DHCP.....	19
SEM Operation .....	20
Overview.....	20
Security Modes.....	20
Point-to-Point Mode.....	20
Point-to-Multipoint Mode.....	21
Co-located Networks .....	22
SEM Command Set .....	23
System Commands .....	23
Bridge Commands.....	25
SEM Security Commands.....	26
Radio Commands.....	27
Specifications.....	31
Connectors .....	31
Indicators .....	31
Power.....	31
Troubleshooting .....	32
Technical Support.....	32
Warranty .....	33

## **Introduction**

The SEM2410 family of products from Cirronet™ Incorporated provides wireless Ethernet connectivity between networks located more than 5 miles apart. Built around the WIT2410 frequency hopping spread spectrum data modem, SEM products provide a 10/100BaseT connection to Ethernet networks. SEM products operate in a point-to-point mode or a point-to-multipoint mode using a star configuration. The center of the “star” is the Master device and the remote SEMs are Slave devices. Peer-to-peer communication is accomplished by using the master SEM device to relay datagrams from one slave SEM device to another slave SEM device.

SEMs come in heavy duty, aluminum enclosures suitable for the rugged industrial environment. The D models come in a DIN rail mount, rugged enclosure designed for factory and industrial applications. The X models features a remote radio housed in a NEMA 4X/IP66 rated enclosure that can be mounted outdoors up to 300 feet from the network connection. Communication between SEM products is performed using the WIT2410 over-the-air protocol. Thus the SEM products are 802.3 compatible but not 802.11 compatible and provide 230Kbps full duplex data throughput. Certified by the FCC and ETSI, and CE marked, SEM products can be deployed license-free around the world.

The SEMs enjoy the same benefits of frequency-hopping spread spectrum technology that the WIT2410s do. Namely, the immunity to multipath fading and resistance to jamming that is provided by changing frequency every few milliseconds. Operating in the 2.4GHz ISM band, SEMs can be used license-free worldwide.

The radios in SEM products include a robust over-the-air protocol. This protocol insures error-free data through the use of a 24-bit CRC and ARQ to detect errors and to automatically request a retransmission. All of this is transparent to the network which just sees complete error-free data.

## Getting Started

The SEM family of wireless Ethernet modems is easy to install and operate. In most instances, the only installation steps will be setting IP addresses, configuring one SEM as the master and connecting the antenna, power and Ethernet cable. While the operation of the SEM2410/D and SEM2410X/DX is the same, the installation and connection is slightly different. Please refer to the appropriate section below for connection and installation of your product.

Setting up a pair of SEMs requires the following steps:

- Enter IP addresses into each SEM
- Configure one SEM as the Master

The default settings in the SEMs are sufficient to allow connection to Ethernet networks and to have the slave SEM connect with the master. Other steps you may want to take include:

- Enter a default route IP address if data is to be sent off the SEM's subnetwork (See *Ethernet Commands*)
- Enable one or more of the security features of the SEM (See *Security Commands*)
- Adjust the RF bandwidth allocation (See *Radio Commands*)
- Filter out broadcast and multicast packets (See *Bridge Commands*)
- Change the network number (See *Radio Commands*)

Instructions on setting up the SEMs are detailed in the *Configuring the SEM* section of this manual. Details on the various operating modes and configurations can be found the *SEM Operation* section.

**SEM2410, SEM2410D**

Figures 1, 2 & 3 show the various connectors and LEDs on the SEM2410 and SEM2410D.

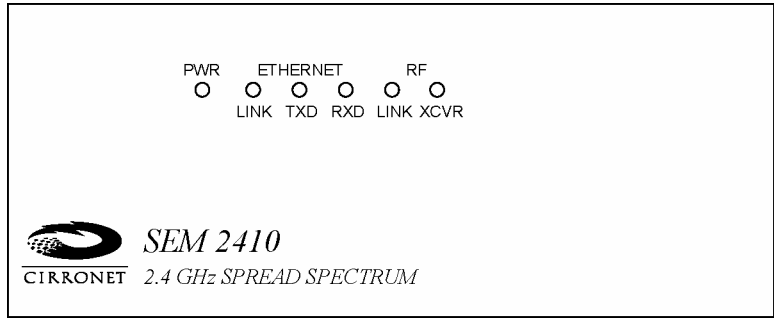

**Figure 1. SEM2410 Front Panel Diagram**

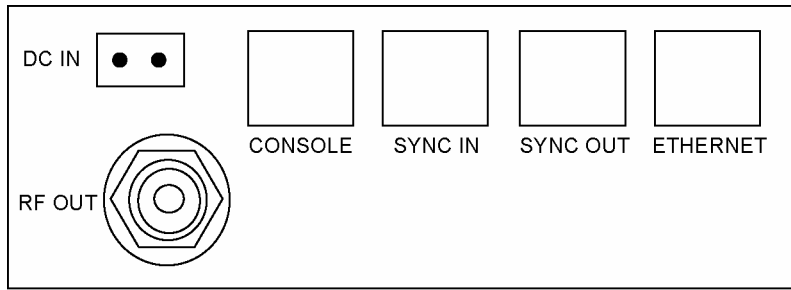

**Figure 2. SEM2410 Back Panel Diagram**

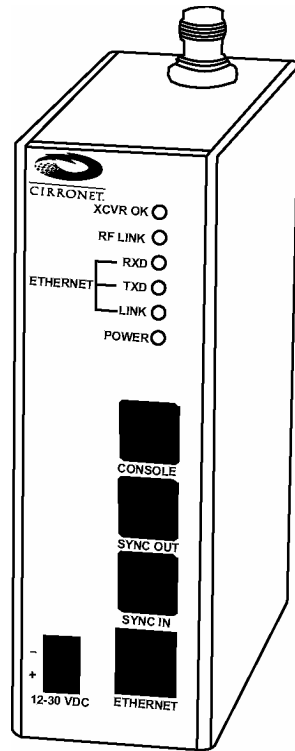

**Figure 3. SEM2410D Front Panel Diagram**

The antenna connector is a reverse-TNC type connector to which an antenna may be connected. Alternatively, an antenna may be located away from the SEM using RF cable to connect the SEM to the antenna. Cirronet does not recommend using RF cables longer than 5 feet. If more distance is required between the SEM and the antenna, high-quality, low-loss RF feed line must be used.

### **Connectors**

The RF connection on the SEM is the antenna on the top of the SEM2410D. The antenna connector is a reverse-TNC male type connector. An antenna may be connected directly to this connector. Alternatively, an antenna may be located away from the SEM using RF cable to connect the SEM to the antenna. Cirronet does not recommend using RF cables longer than 5 feet. If more distance is required between the SEM and the antenna Cirronet recommends using the SEM2410X/DX. If the SEM2410X/DX is not used, high-quality, low-loss RF feed line must be used.

The 10/100BaseT Ethernet connector is the standard RJ-45 connector located on the front of the SEM2410D and the rear of the SEM2410. The SEM is set up to use a straight through cable to connect to a PC. If a straight through cable is used to connect the SEM to other devices through a hub, the SEM must be connected to the uplink port on the hub. Both a straight-through and a crossover Ethernet cable are included.

The SYNC IN and SYNC OUT signals are provided for special applications where multiple master SEMs are co-located. The synchronizing signals are RS-485 levels and may be connected using an RJ-11 connector. If the sync signals are required, one of the master SEMs must be designated as the sync master. See the section *SEM/Radio* Commands for details. If there are no co-located master SEMs, sync should be left disabled.

The Console port is an RS-232 serial port that may be used to configure the SEM. Connection to this port is made with the 9-pin to RJ-11 serial cable included with the SEM. This is useful when the default IP address of the SEM cannot be used with the existing network preventing configuration through a telnet session. See the section *Configuring the SEM* for details of using this port.

The power connector is a 2-pin terminal block connector. The provided AC adapter provides a 12 volt power level to the SEM. The SEM can accept DC voltages ranging between 9VDC and 30VDC if alternative power supplies are to be used.

### **Status Indicators**

The PWR indicator on the front panel indicates that power is applied to the SEM. The SEM does not have a power switch. Power is applied and removed to the SEM by connecting and disconnecting the power connector.

The Ethernet LEDs include LINK, TXD and RXD. The LINK LED lights when a valid Ethernet connection is made. The SEM is set up to use a straight through cable to connect to a PC. If a straight through cable is used to connect the SEM to other devices through a hub, the SEM must be connected to the uplink port on the hub. TXD and RXD are indicators of Ethernet data activity. They indicate the transmission and reception of data over the Ethernet connection. Note that these LEDs can be active even when the SEM is not communicating with another SEM.

On a slave SEM, the RF Link LED indicates the SEM has established a connection with the master SEM. When a slave SEM is powered on, it will take a few seconds for this LED to turn

on. On a master SEM the RF Link LED is on as long as any one Slave is linked. On the X and D models , the XCVR OK LED indicates that the remote radio assembly is connected and operating properly.

## SEM2410X/DX

Figures 4, 5 & 6 show the connectors and LEDs on the SEM2410X & SEM2410DX radios. Figure 7 illustrates the remote radio assembly. Connection between the SEM2410X and SEM2410DX enclosures and the remote radio assembly is made through the 15-terminal connector on the front of the radios. Digital signals, rather than RF signals are sent over the connecting cable which may be up to 300 feet in length. These cables may be ordered from Cirronet in lengths of 100 feet to 300 feet in 100-foot increments.

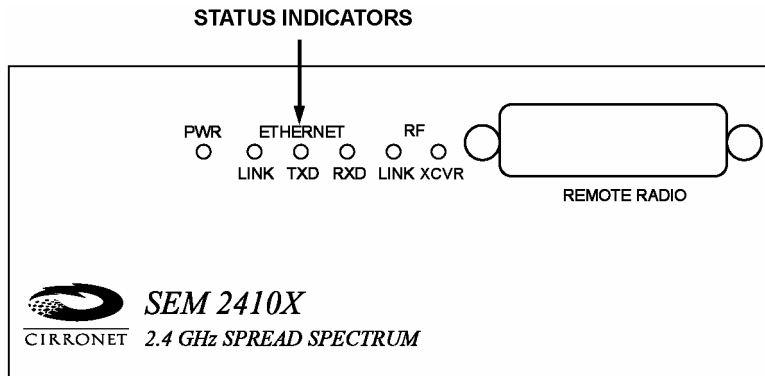

**Figure 4. SEM2410X Front Panel Diagram**

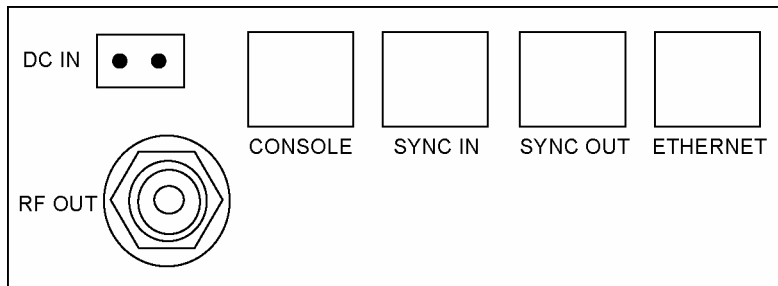

**Figure 5. SEM2410X Back Panel Diagram**

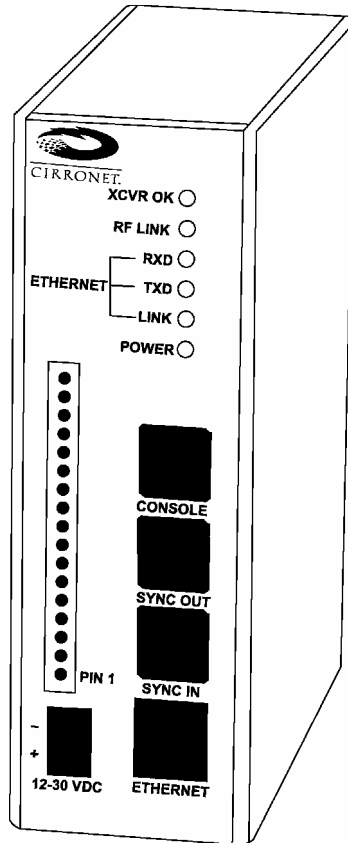

Figure 6. SEM2410DX Front Panel Diagram

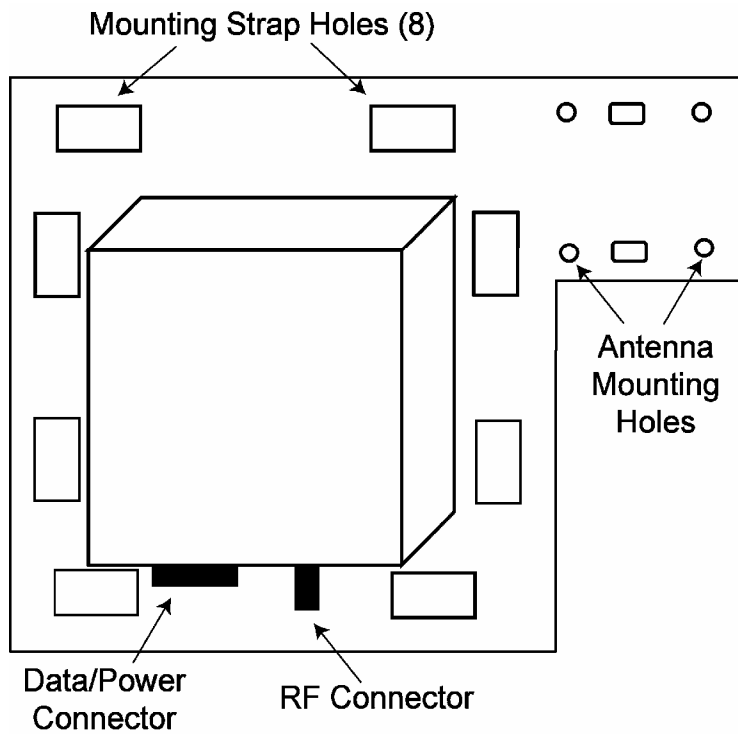

Figure 7. Remote Radio Assembly

The remote radio assembly has mounting holes to secure the antenna. The antenna is attached to the remote radio through the included 24-inch RF cable. If the antenna is not to be mounted on the remote radio assembly, connection between the remote radio and the antenna must be made with high-quality, low-loss RF cable. Cirronet recommends limiting the length of the RF cable to 5 feet to minimize RF signal loss.

Note that the remote radio assembly should be mounted on a tower or building top oriented as in Figure 3. It is important that the RF connector on the remote radio assembly point to the ground to avoid any issues with rain water.

### Attaching the Remote Radio Connector – SEM2410X

The figure below shows the pin numbering of the Remote Radio connector. The view provided is looking into the side of the connector into which the pins will be inserted.

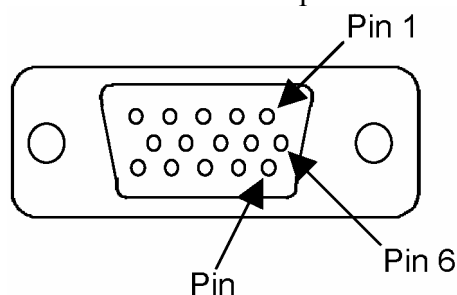

The cable pins are installed by choosing the appropriate conductor color and connector hole location and inserting the pin into the hole until it “clicks” into place. Verify the pin is locked into place by gently pulling on the conductor.

If a pin is installed in the wrong connector location, use the extractor tool to remove the pin. Insert the extractor tool into the connector hole such that the tool surrounds the pin. Gently push the extractor tool completely into the hole. Remove the pin by gently pulling on the conductor. If the pin does not come out easily, it is an indication the tool is not fully inserted. Do not pull on the conductor forcefully as that can pull the conductor out of the pin.

Use the following color code to insert the pins into the connector:

CONNECTOR PIN	CONDUCTOR COLOR	CONNECTOR PIN	CONDUCTOR COLOR
1	Brown	9	Green
2	Orange/Black	10	Orange
3	Black	11	Violet
4	Blue	12	Yellow
5	Tan	13	White/Black
6	Pink	14	Grey
7	White	15	White/Red
8	Red		

Care must be taken to follow the color code correctly. An incorrectly assembled connector can damage the radio or the card or both.

Complete the assembly by placing the connector in the slot in one of the shell halves. Install the two retaining screws on both sides of the shell and through the holes on both sides of the connector; place the other shell half over the connector so the connector lies in the shell slot. Secure the connector shell halves with the nuts and bolts provided.

Refer to the figures below.

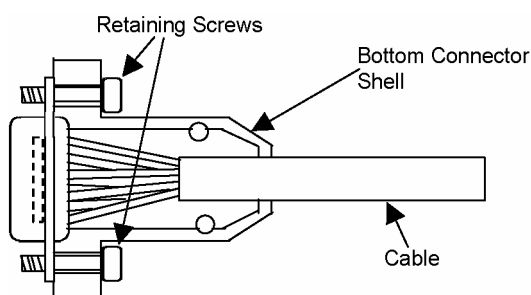

Pinned connector in bottom connector shell

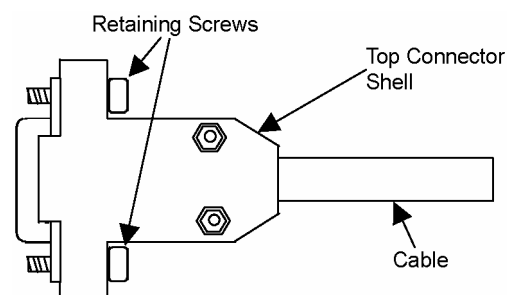

Completed connector with top connector shell attached.

### Attaching Remote Radio Connector – SEM2410DX

The figure below shows the pin numbering of the Phoenix Contact, 16 pin, 3.81mm Remote Radio connector (P/N1803714). The view provided is facing the side of the connector with the screw heads showing.

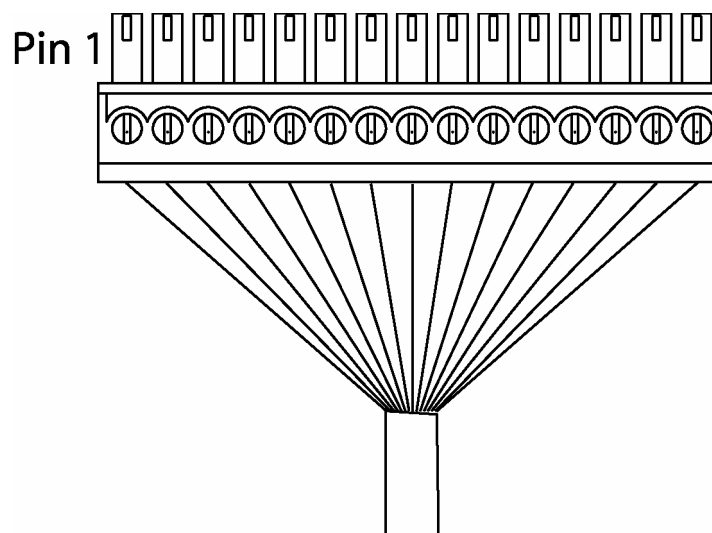

The cable comes with pins pre-crimped onto the conductors and is assembled by inserting a crimped pin into a hole location, then tightening the screw to hold the pin securely. To verify the pin is held firmly in place, gently pull on the conductor wire.

If a pin is accidentally installed in the wrong connector location, simply loosen the screw, remove the pin, re-insert it into the proper location hole and tighten the screw. Use the following color code to insert the pins into the connector:

CONNECTOR PIN	CONDUCTOR COLOR	CONNECTOR PIN	CONDUCTOR COLOR
1	Brown	9	Green
2	Orange/Black	10	Orange
3	Black	11	Violet
4	Blue	12	Yellow
5	Tan	13	White/Black
6	Pink	14	Grey
7	White	15	White/Red
8	Red		

Care must be taken to follow the color code correctly. An incorrectly assembled connector can damage the radio or the card or both. The picture below shows the completed cable assembly.

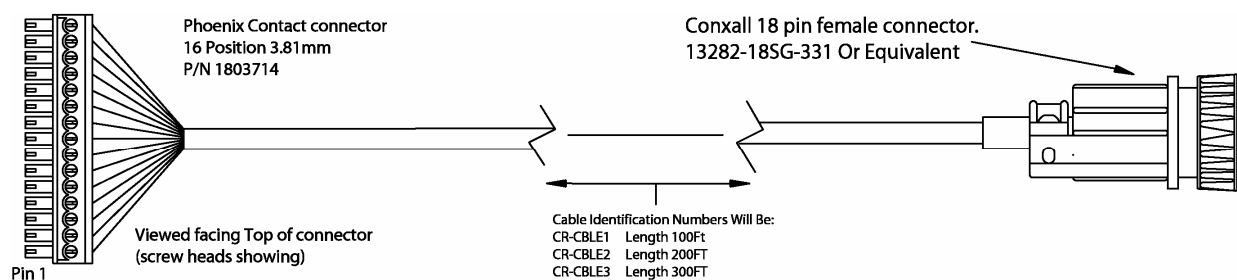

### Important Note:

**If an alternate source of power is used with the SEM2410DX, it must be limited to +12VDC +/-10%. Failure to meet this specification can result in damage to the remote radio assembly.**

### Connectors

The 10/100BaseT Ethernet connector is the standard RJ-45 connector and is located on the front of the SEM2410DX and the rear of the SEM2410X. The SEM is set up to use a straight through cable to connect to a PC. If a straight through cable is used to connect the SEM to other devices through a hub, the SEM must be connected to the uplink port on the hub. Both a straight-through and a crossover Ethernet cable are included.

The SYNC IN and SYNC OUT signals are provided for special applications where multiple master SEMs are co-located. The synchronizing signals are RS-485 levels and may be connected using an RJ-11 connector. If the sync signals are required, one of the master SEMs must be designated as the sync master. See the section *SEM/Radio Commands* for details. If there are no co-located master SEMs, sync should be left disabled.

The Console port is an RS-232 serial port that may be used to configure the SEM. Connection to this port is made with the 9-pin to RJ-11 serial cable included with the SEM. This is useful when the default IP address of the SEM cannot be used with the existing network preventing configuration through a telnet session. See the section *Configuring the SEM* for details of using this port.

The power connector is a 2-pin DIN type connector. The provided AC adapter provides a 12 volt power level to the SEM. The SEM2410 and SEM2410DX can accept DC voltages ranging between 12VDC and 30VDC if alternative power supplies are to be used.

### **Status Indicators**

The PWR indicator on the front panel indicates that power is applied to the SEM. The SEM does not have a power switch. Power is applied and removed to the SEM by connecting and disconnecting the power connector.

The Ethernet LEDs include LINK, TXD and RXD. The LINK LED lights when a valid Ethernet connection is made. The SEM is set up to use a straight through cable to connect to a PC. If a straight through cable is used to connect the SEM to other devices through a hub, the SEM must be connected to the uplink port on the hub. TXD and RXD are indicators of Ethernet data activity. They indicate the transmission and reception of data over the Ethernet connection. Note that these LEDs can be active even when the SEM is not communicating with another SEM.

The RF indicators include LINK and XCVR OK. On a slave SEM, the RF Link LED indicates the SEM has established a connection with the master SEM. When a slave SEM is powered on, it will take a few seconds for this LED to turn on. On a master SEM the RF Link LED is on as long as any one Slave is linked. When the XCVR OK LED is on, that indicates the remote radio is operating properly.

## Configuring the SEM

The network that the SEM is connected to must be compatible with 10/100BaseT products. Before connecting a default configured SEM to an active network that does not have a BOOTP or DHCP server, ask the network system administrator for an IP address for the SEM that will not cause any problems on the network.

### Setting IP Addresses

SEMs are shipped from the factory with default settings that include a default IP address of 0.0.0.0 and a default configuration as a slave bridge. In order to set up a wireless link, alternate IP addresses need to be assigned and one of the SEMs must be configured as a master device. If a BOOTP or DHCP server is not present a different IP address must be assigned to the SEM. If a DHCP server is present on the network, the IP address can be set up through it.

The Master SEM can obtain its IP address through a DHCP server residing on the Master SEM's local network. The slave SEMs receive their IP address through the Master SEM from the DHCP server on the Master SEM's local network. If the slave SEM cannot establish a link with the master SEM (due to different network numbers or some other configuration setting), the slave SEM will need to have its IP address entered manually unless it will be configured through the console port. If it is desired to configure the slave SEM through a browser session instead of the console port but use a DHCP server to provide the IP address after initial setup, a temporary IP address can be assigned manually but the IP address will need to be reset to 0.0.0.0 to have the slave SEM obtain its IP address from the DHCP server.

### IP Hunter Utility

The SEM2410 CD has a device detection and IP setting utility named IP Hunter. This utility will detect all Cirronet Ethernet devices on the local network, even those with no IP address. For those units without an IP address, IP Hunter can set the IP address and then open a browser session with that device to allow for further configuration. The IP Hunter will display devices that already have IP addresses and will open browser sessions with those units, but will not change the IP address already set.

Open IP Hunter by double-clicking on the file iphunter.exe on the SEM2410 CD. The following screen will appear.

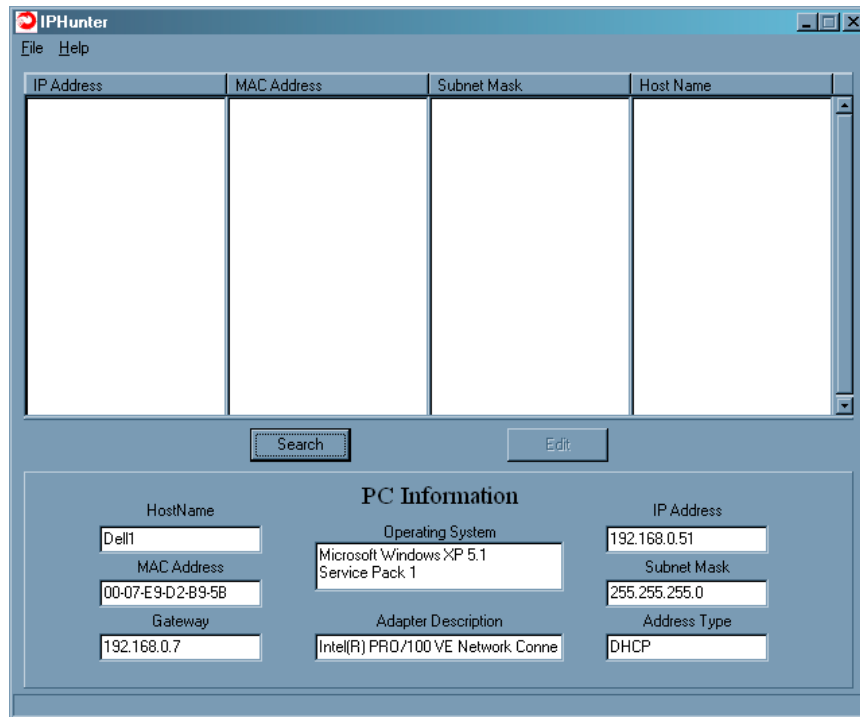

Click on the Search button to begin the search for Cirronet devices. Only Cirronet Ethernet devices will be displayed as shown below.

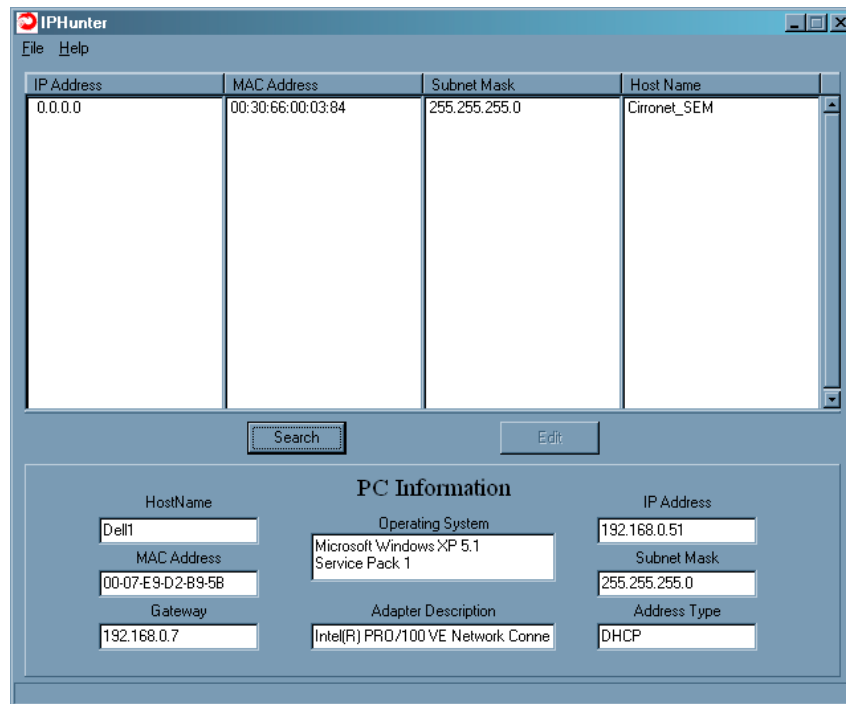

Ethernet devices from other manufacturers will not be displayed, even if they have no IP address. Any devices found will be displayed on the screen along with the IP address (if any), the netmask the MAC address and the DHCP host name.

Double-clicking on a device with an IP address of 0.0.0.0 will bring up the following dialog box.

Change Parameters

IP Address  
0 . 0 . 0 . 0

SubNet Mask  
255 . 0 . 0 . 0

Host Name  
Cirronet\_SEM2

MAC Address  
00:30:66:00:55:69

OK Cancel

Enter the desired IP address and the default netmask will automatically be entered as shown below. A new Host Name may be entered if desired; however, the MAC Address cannot be changed.

Change Parameters

IP Address  
192 . 168 . 0 . 250

SubNet Mask  
255 . 255 . 255 . 0

Host Name  
My Computer Name

MAC Address  
00:30:66:00:55:69

OK Cancel

Click OK and the IP address will be entered in the SEM2410 and will be displayed in the IP Hunter window as shown below.

IPHunter

File Help

IP Address	MAC Address	Subnet Mask	Host Name
192.168.0.33	00:30:66:00:03:84	255.255.255.0	Cirronet_SEM

Search Edit

PC Information

HostName Dell	Operating System Microsoft Windows XP 5.1 Service Pack 1	IP Address 192.168.0.51
MAC Address 00-07-E9-D2-B9-5B	Adapter Description Intel(R) PRO/100 VE Network Conne	Subnet Mask 255.255.255.0
Gateway 192.168.0.7		Address Type DHCP

## HTML Setup

Once an address has been assigned, double-click on the IP number to launch an HTML setup session in a browser window. The login screen will display as shown below.

Enter the default Username, “admin” and the default Password, “Cirronet” (case sensitive).

(The password will be displayed as dots only for security purposes.)

Username

Password

Click on OK and the main browser window is displayed.

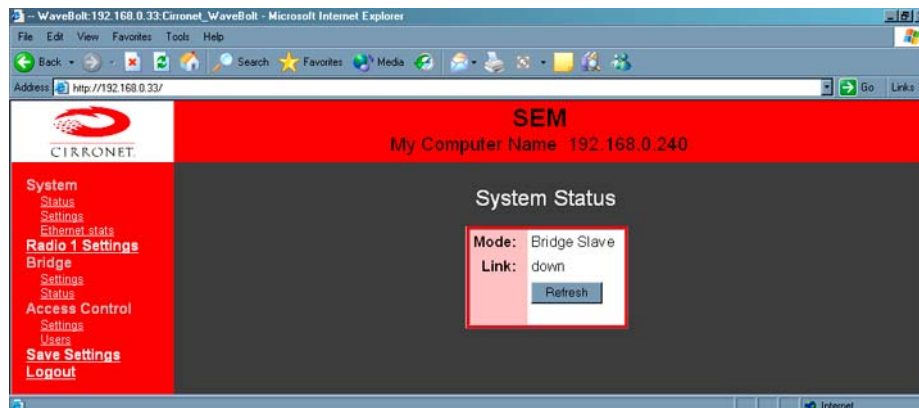

## System Status

Mode:	Bridge Master
Link:	down
<input type="button" value="Refresh"/>	

This dialog shows the Mode (Master or Slave) and Link (Up/Down) status of each device. (Clicking on Refresh should be used when System Settings have been adjusted to display current status.)

## System Settings

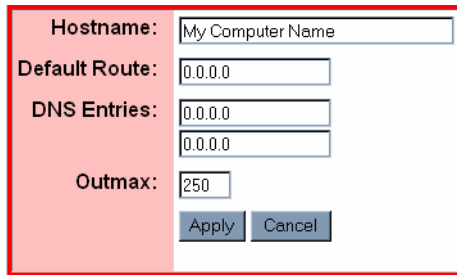

The System Settings dialog box contains the following fields and buttons:

- Hostname:** My Computer Name
- Default Route:** 0.0.0.0
- DNS Entries:** 0.0.0.0 (two entries)
- Outmax:** 250
- Buttons:** Apply, Cancel

This dialog allows the user to change the Hostname, set the Default Route, enter DNS entries or change the Outmax (upload/download ratio for the radio) setting. If the SEM2410 is to transmit data to devices not on its subnet, a default router must be specified. To set the default routing address, enter it in the Default Route field. Click on Apply to invoke changes, click on Cancel to discard.

## System Ethernet Stats

Receive:		Transmit:	
Good Packets Received:	121047	Transmits Error free:	409
For this device:	316	Output queue packets:	1
Multicast:	2215		
Broadcast:	50757		
Interrupts:	119570		
Receive errors:		Transmit errors:	
Too long:	0	Defers:	0
Non-octet aligned:	0	Heartbeat errors:	0
CRC errors:	0	Late collisions:	0
Overruns:	8	Retransmit limit:	0
Truncated:	0	Underruns:	0
Partial:	0	Carrier sense lost:	4

This dialog displays statistics related to the transmission and reception of wired Ethernet data.

## Radio Settings

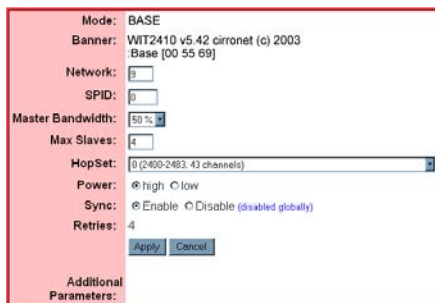

The Radio Settings dialog box contains the following fields and options:

- Mode:** BASE
- Banner:** WIT2410 v5.42 cirronet (c) 2003 Base [00 55 69]
- Network:** 8
- SPID:** 0
- Master Bandwidth:** 50 %
- Max Slaves:** 4
- HopSet:** 0 (2400-2483.43 channels)
- Power:**  high  low
- Sync:**  Enable  Disable (disabled globally)
- Retries:** 4
- Buttons:** Apply, Cancel
- Additional Parameters:** (empty field)

This dialog identifies the radio and current operating mode. It also allows the user to configure radio parameters for the Network, SPID, Master Bandwidth, Max Slaves, HopSet, Power, Sync and Retries. Details on these settings are provided in the section on Radio Commands.

## Bridge Settings

This dialog allows the user to set the Mode, (Master or Slave), any Filtering (see the section on Filtering below) and whether or not a Login is required. Selecting “No” grays out the Username/Access-code, Password and (Password) Verify fields. Selecting “Yes” allows entries to be entered into the fields. Details on these settings are provided in the section on Bridge Commands.

## Bridge (Connection) Status

User	IP-address	Radio ID	InPkts	InBytes	Errs	OutPkts	OutBytes
------	------------	----------	--------	---------	------	---------	----------

This dialog displays statistics related to the connected radios including UserName (if no username is assigned, N/A will display), IP Address, Radio ID and Packet/Error Information.

## Access Control Settings

This dialog allows the setting of login preference, “admin” (default), “enable” or “guest”. Setting “admin” allows the user rights to change parameters; setting “guest” limits the access to RF Tools only. After changing the Console setting, click Apply to invoke the changes. Click on Cancel to discard any changes.

Clicking on Enable IP address control and then Apply brings up the dialog below.

## Enable IP address Control

This dialog is used to designate the Allowed IP addresses from which the SEM2410 will accept a telnet session request. Simply enter an IP address in the “Allowed IP address” field and click “Add IP address. Only IP addresses designated by this dialog can access the device when IP address control is Enabled.

## Access Control Users

Username	Enable	Access level	
admin	ENABLED	admin	Modify user
guest	ENABLED	guest	Modify user
			Add a new user

This dialog allows the modification of logins and the ability to add new users.

**Note:** Click on **Save Settings** to store the system configuration changes in non-volatile FLASH memory. The user may either click on “Reset” to reboot the processor, click on “Logout” to end the browser session or simply close the browser window.

## Console Port

The SEM can be configured two ways: Through a browser session once an IP address has been obtained and through a serial session through the console port. The settings for the console port are 38400 baud, 8 data bits, 1 stop bit, and no parity. The WinSEM program can be used to set up the SEM through the Console port. The appropriate serial port must be selected in WinSEM, but the program will automatically set up the serial port. After a few seconds the SEM firmware version is displayed followed by the **SEM>** prompt.

To set the IP number of the SEM, use the *ip* command.

```
ip <xxx.xxx.xxx.xxx> {YYY.YYY.YYY.YYY}
```

Where x is the new IP address and y is the optional netmask number.

Once a valid IP address has been entered in the SEM, a second method to configure the SEM is through a telnet session. Most telnet programs work with the SEM. Windows 95/98/NT/2000/ME have a telnet program that works with the SEM. A telnet session can be started by clicking on Start->Run if you have Windows 95/98/NT/2000 and the TCP/IP client has been installed. For a SEM with an IP address of 192.168.0.254, enter the following information in the dialog box:

```
telnet 192.168.0.254
```

A telnet window will open up prompting for a Username/Password. The default Username is “admin”, the default Password is “Cirronet”. The first line is the version of the SEM firmware followed by the prompt:

```
SEM>
```

If the SEM is to transmit data to devices not on its subnet, a default router must be specified. To enter the default routing address, use the *route* command.

```
route add default <xxx.xxx.xxx.xxx> {YYY.YYY.YYY.YYY}
```

Where x is the IP address of the gateway device and y is the optional netmask number.

To configure a SEM as a master device, use the *bridge* command:

```
bridge master<CR>
```

Store the changed configuration parameters in non-volatile memory with the *save* command:

```
save<CR>
```

The SEM will report back the time it took to save the information. Reset the SEM by typing:

```
reset<CR>
```

The SEM can also be reset by cycling power. Whenever a reset is executed on the SEM, the telnet session will be lost. It will take the SEM about 30 seconds to reinitialize after a reset or after cycling power.

**Note: Failure to save and reset will result in the factory defaults being used.**

### Filtering

The SEM2410 includes provision for filtering of multicast and broadcast packets. In many networks, there is sufficient multicast and/or broadcast packets to slow the overall performance of the SEM. Based on the number of broadcast and multicast packets, they can consume a substantial amount of the RF bandwidth. By turning filtering on, the SEM will ignore these packets and limit transmission to packets with specific device addresses. In some instances, it will be desired to have the SEM transmit the multicast and broadcast packets; in this instance filtering should be disabled. Note that filtering broadcast packets also filters multicast packets but filtering multicast packets does not filter broadcast packets. To filter broadcast and multicast packets use the bridge filter command:

```
bridge filter bcast<CR>
```

Refer to the section *Bridge Commands* for details of the filter commands.

### DHCP

A DHCP server can set the SEM IP address as well as the default route IP address. This is accomplished by setting the desired default route IP address in the DHCP server using Option 3. A DHCP server will not overwrite a previously entered default router IP address in the SEM. If a DHCP server is not used to set the default router IP address, one must be entered using the *route* command. See the previous section for details of the route command. If an IP address has previously been entered into the SEM but a DHCP server is to be used to assign an IP address, it will be necessary to set the IP address in the SEM to 0.0.0.0 using the **ip** command.

## SEM Operation

### Overview

SEM devices are wireless Ethernet modems that perform bridging functions in point-to-point or point-to-multipoint configurations. SEM products are designed to connect remote network segments together while keeping the data traffic between the network segments to a minimum. SEM products use MAC-layer addresses to learn on which network segment a device is located.

A master SEM can connect up to 15 remote slave SEMs. The SEM2410 is a single channel device with an over-the-air data rate of 460Kbps providing up to 230Kbps full duplex data throughput. The radio modems in the SEMs are factory configured with optimum settings for typical point-to-point applications. The radio parameters can be configured to optimize data throughput, latency and range for whatever the application. In addition, the radios in the SEMs can be configured to allow multiple SEM networks to be co-located.

### Security Modes

The SEM provides several security modes that protect against unauthorized control of the SEM and unauthorized access to the network to which the SEM is connected.

The first security feature is the need for a password to connect to a SEM remotely through a telnet session. The password is enabled and cannot be disabled. When a telnet session is initiated, a password must be entered to gain access to the command line mode of the SEM. The default password is “Cirronet” (no quotes, case sensitive) but should be changed immediately. When you change the password, please make note of it and save it in a secure location as there is no way to recover lost passwords. Another feature is available to limit the ability to initiate telnet sessions with the SEM. The `access ip add` command is used to add specific IP addresses from which telnet sessions will be allowed. Up to 10 IP addresses can be entered. This feature is defaulted OFF and is enabled through the `access ip enable` command.

The same password required for a telnet session may also be required for a serial connection to the console port. The default for this feature is Off. It is set using the `access console enable` command. When enabled, the same password used for the telnet session will be required to gain access to the command line interface of the SEM through the console port.

Similar to the telnet/console password is the FTP password. This password is always required and cannot be disabled. The default password is “Cirronet” (no quotes, case sensitive) but should be changed immediately. When you change the password, please make note of it and save it in a secure location as there is no way to recover lost passwords.

To provide security from unauthorized SEMs gaining access to a SEM network, an access code/password feature is available. This feature requires slave SEMs to authenticate with the master before being granted access to the network. This feature is defaulted OFF and is set up using the `bridge login`, `bridge access` and `bridge password` commands.

Details of all the security-related commands are found in the *Bridge Commands* and *Security Commands* sections of this manual.

### Point-to-Point Mode

In point-to-point operation, one SEM is configured as the Master and the other is configured as a Slave. While this is necessary for operation, it does not matter which SEM is the master and which is the slave. The radio in the master operates as the base radio. Configuring the SEM as

the master automatically configures the radio in the master as a base radio. Similarly, configuring a SEM as a slave automatically configures the slave radio as a remote radio.

When a master SEM is powered on, it becomes active immediately, even if no slave SEMs are detected. It will attempt to send packets addressed to devices that it thinks are not on its local network. When a slave SEM is powered on, it listens for a master SEM and attempts to register with the radio in the master. This detection and registration process can take up to 2 seconds. During this time, no packets will be sent or received over the RF link by the slave.

If the application is such that more than one point-to-point link needs to be located in the same area, each master/slave pair must be assigned different network numbers. This will allow the SEMs to identify the appropriate other SEM to which they should communicate. Because different network numbers have different hopping sequences, this also allows various pairs to operate in the same area without interfering with each other. Refer to the section on radio commands for details on setting network numbers.

### Point-to-Multipoint Mode

In point-to-multipoint mode multiple slave SEMs link with a single master SEM. Similar to the point-to-point mode, each slave must register with the master, a process that can take up to 2 seconds. All of the radio addressing and registration occurs automatically and is transparent to the application. A maximum of 15 slave SEMs can be connected to a master SEM. The amount of data a slave can transmit depends on the number of slaves connected and the hop duration of the radio network. Because packets from one slave that are intended for another slave must pass through the master SEM, the master SEM should always be allocated 50% of the data throughput, even at the expense of some throughput for the slaves. This is the factory default configuration.

In frequency hopping technology, the following applies... the shorter the hop duration, the lower the data latency but also the lower the throughput. This is because the overhead required is the same regardless of the hop duration. Thus at shorter hop durations, the overhead is a larger percentage of the hop time. Longer hop durations provide more throughput but have a higher data latency. If data from a slave appears just after the slave's designated transmit time, the slave will have to wait one hop duration before it can transmit the data. As the hop durations of the SEM products are very short, ranging from 7.5ms to 17.5ms, the better approach is to pick the hop duration to maximize data throughput without unnecessarily penalizing latency.

The factory configuration is set up that the master will have one-half of the bandwidth reserved for it. The slave devices split the remaining time equally and transmit as much as they can each hop. The amount of time remaining will depend on the hop duration. The table below gives data throughputs for multiple slaves based on the default hop duration for a SEM.

Slaves	Hop Duration	Slave Throughput	Master Throughput	Aggregate Throughput
1	10ms	208Kbps	208Kbps	416Kbps
2	10ms	118.6Kbps	208Kbps	445.2Kbps
3	10ms	69.5Kbps	208Kbps	416.5Kbps
4	10ms	44.8Kbps	208Kbps	387.2Kbps

If the application has more slave devices, or if it is desirable to increase the throughputs of the slaves at the expense of the master SEM, contact Cirronet technical support for more details.

### **Co-located Networks**

The radio architecture in the SEM allows multiple networks to be located in the same area without interfering with each other. Depending on the scenario, either the network and/or the sync commands are used to distinguish between networks of SEMs and to prevent interference between the SEM networks.

If the master SEMs are not located close to each other (< 30 feet or 10 meters), simply assigning different network numbers to the various networks of SEMs will allow the networks to co-exist without interference. The network number selects one of 63 different hopping patterns, where the hopping pattern is the pseudo-random sequence of frequencies over which the SEMs hop. Because the different networks are using different sequences they will transmit on the same frequency at the same time only rarely. These infrequent collisions are sufficient to reduce the throughput in any meaningful way.

If the master SEMs are to be located close together, the SEMs allow the masters to be synchronized as to when they send to slaves and when they receive from slaves. This synchronization is allowed by the FCC in the United States. The FCC does not allow synchronizing of the hop sequences to avoid all collisions. The SEM accomplishes the send/receive synchronization through use of the Sync ports. The Sync ports of the SEM masters are connected using standard RJ-11 cables. There is a Sync In and a Sync Out port to allow daisy-chaining of SEM masters. One of the SEM masters is designated the Sync Master using the **sync master** command. Synchronization is enabled in the Sync Master and all connected master SEMs using the **sync enable** command. The **sync wire** command must be issued to turn on the Sync ports. Refer to the *Radio Commands* section for details.

**Note: When synchronization is used in the United States, the hop fcc parameter must be left enabled. Disabling this parameter will violate FCC rules governing spread spectrum radios.**

## SEM Command Set

The SEM supports a series of commands that allow for configuring the Ethernet interface as well as the radio parameters of the on-board WIT2411. These commands can be entered during a telnet session or by using the WinSEM24 utility when the SEM> prompt is displayed. The commands are grouped into System, Bridge, Security, Ethernet and Radio command sets. The commands are summarized here with detailed explanations following.

### System Commands

Command	Description
help	Displays command help screen
arp -a -d <ipaddr> -s <ipaddr> <eaddr>	Displays arp table Deletes arp entry Adds arp entry
default	Sets SEM configuration to factory default settings
echo	Toggles user screen echo mode
ip [ <ipaddr> <netmask>]	Displays current SEM IP address Sets SEM IP address and optionally the netmask
ping <ipaddr>	Pings TCP/IP host
reset	Resets the SEM activating changed configuration parameters
route [ help add <default> <gwaddr> <netmask> del <ipaddr> list ]	Displays help screen for command Adds IP address and netmask to route list Deletes IP address from route list Lists route IP addresses
save	Stores current configuration to memory
sys help mode outmax  (Master only)	Displays sys help screen Displays Master/Slave mode of the SEM Sets maximum number of bytes Master SEM can transmit per hop. Range is from 1 to 208 Default = 208
version	Displays SEM firmware version

**help** Displays a list of all the SEM commands. Most commands that require a parameter also have a help mode that displays the help screen for that command.

arp	Manipulates the address resolution procedure table. This command is provided primarily as a debugging tool for setting up networks. <b>ipaddr</b> is the device IP address and <b>eaddr</b> is the physical Ethernet address of the device
default	Resets SEM configuration parameters to factory default settings. This command does not reset the radio parameters. Use the <b>radio default</b> command to reset the radio parameters. See the section on <i>Radio Commands</i> for details.
echo	Toggles the user screen mode to echo characters typed by the user. Default is on. If echo is turned off, characters typed will not be displayed on the screen unless echoed by the terminal program.
ip	Sets the IP address of the SEM. The default IP address is 0.0.0.0. When specified, <b>netmask</b> sets the netmask number. The default netmask is 255.255.255.0.
ping	Sends inquiry packets to TCP/IP host specified in <b>&lt;ipaddr&gt;</b> and displays the amount of time that elapsed before a response was received. Continuously sends requests until a key is pressed.
reset	Resets the SEM and loads saved parameters into active memory. Also causes the SEM to reinitialize which can take 30 seconds. If reset is issued before the save command, the new parameters are lost and the last saved parameters are used.
route	Displays and manipulates gateway IP addresses to route IP traffic off the subnet. <i>Default</i> sets the first gateway attempted.
save	Saves changed parameters in non-volatile memory to be loaded on power up. Must be issued before the reset command or cycling power to have changed parameters take effect. (An exception is the <b>sys outmax</b> command which becomes active immediately after it is entered.)
sys	<b>mode</b> displays whether SEM is configured as a Master or Slave. Setting Master or Slave mode is performed using the bridge command. Refer to the section <i>Bridge Commands</i> for details.  <b>outmax</b> controls how data is presented to the SEM radio. This command should not be used without advice from Cirronet Technical Support.
version	Displays the SEM firmware version.

## Bridge Commands

Command	Description
bridge help	Displays help screen for command
access <accesscode>	Sets access code to allow slave SEM onto to Master's network. Slave accesscode must match accesscode of desired Master
filter [disable, bcast, mcast, show]	Selects filtering operation and level.
login [enable disable]	Enables/disables accesscode/password login authentication. Must be set in master and slave
master	Sets SEM as Master bridge
password <pwr>	Sets login password. Slave password must match password of desired Master SEM
slave	Sets SEM as Slave bridge (default)
status (Master only)	Displays status of active connections

- access** Sets the **accesscode** portion of the **accesscode/password** pair to allow slave SEMs to connect to a master SEM. **accesscode** must match the **accesscode** in the master SEM.
- filter** Selects Ethernet traffic filtering mode.  
**filter disable** turns filtering off. **filter bcast** filters out broadcast and multicast packet while **filter mcast** filters out just multicast packets. **filter show** displays the filter settings.
- login** Turns the authentication login requirement off and on. When on, Enabled, an accesscode and password must be entered in the slave SEM that matches the accesscode and password of the master SEM with which the slave SEM wants to establish a connection. Note that the network number of the SEMs must also agree. See the section *Radio Commands* for details on the network number. This feature prevents unauthorized SEMs from connecting to a SEM network.
- master** Sets the SEM as the Master SEM.
- password** Sets the **password** portion of the **accesscode/password** pair to allow slave SEMs to connect to a master SEM. Password must match the password in the master SEM.
- slave** Sets the SEM as a Slave SEM.
- status** Displays the status of active slave SEM connections. (Only available in the master SEM.)

## SEM Security Commands

Command	Description
access help	Displays command help screen
console [enable disable]	Enables/disables password requirement for direct console communications.
ip [help	Displays command help screen
add <ipaddr>	Sets IP addresses (up to 10) from which telnet sessions will be accepted
delete <ipaddr>	Deletes ipaddr from list of allowed telnet initiators
disable	Turns off telnet initiator limitation
enable	Turns on telnet initiator limitations
show]	Displays telnet initiator limitations settings
show	Displays console and IP setting
ftpw	Changes the password for FTP sessions
password <pwd>	Changes the password for telnet/console sessions

**access** Group of commands that limit access to the SEM through the console port and telnet sessions. Note that there is no command to enable or disable the telnet session password. It is always enabled.

**console enable** sets the requirement that a password be entered when starting a console connection. The password is set using the **password** command. The default setting is disabled. **console disable** removes the password requirement.

**ip enable** sets limitations set on initiating a telnet session to the SEM. When enabled, only network devices with IP addresses on the list of IP addresses added can initiate a telnet session with the SEM. Up to 10 IP addresses can be added to the list. The list is modified with the **add** and **delete** subcommands. **ip disable** allows telnet sessions to be initiated from any IP address (a password will still be required). **show** will display the setting of the ip command and the list of IP addressed entered when enabled.

**ftpw** This command changes the password required to initiate an FTP session with the SEM. The default password is “Cirronet” (without quotes). It is not possible to disable this password.

**password** This command changes the password required to initiate a telnet session with the SEM and initiate a serial connection through the console port when enabled. The default password is “Cirronet” (without quotes). It is not possible to disable the password requirement for a telnet session, but it is possible to disable the password requirement for the console connection.

## Radio Commands

Command	Description
<pre>hop [help     fcc [enable disable]     length &lt;hoplen&gt;     sequence [75 25]      set &lt;pattern&gt;                                 (Master only)</pre>	<p>Displays help screen for command</p> <p>Enable/disable FCC hop synchronization</p> <p>Sets/displays hop dwell time in radio and SEM</p> <p>Informs SEM of number of frequencies in radio hop pattern</p> <p>Sets/displays the hop pattern to be used. This is required in countries with limited spectrum.</p>
<pre>slave [help     disconnect &lt;id-id-id&gt;      list]                                 (Master only)</pre>	<p>Displays help screen for command</p> <p>Disconnects slave SEM with the radio serial number entered</p> <p>Displays slaves currently registered with the SEM</p>
<pre>sync [help     disable     enable     master     override     settings     slave     wire]                                 (Master only)</pre>	<p>Displays help screen for command</p> <p>Turns sync off (default)</p> <p>Turns sync on</p> <p>Sets SEM as sync master</p> <p>Toggles master backup override</p> <p>Displays synchronization settings</p> <p>Sets SEM as sync slave</p> <p>Sets synchronization mode to use RJ-11 wire ports</p>

**hop** Used to set the hop dwell time or the number of frequencies in the hop pattern of the radio in the SEM. Master only.

The **fcc** command enables the FCC rules regarding synchronization of frequencies when SEM masters are co-located and synced using the sync signals. The sync signals synchronize the SEM masters such that they will transmit at the same time. FCC rules in the US allow synchronization in time but not frequency. That is, the master SEMs cannot be synchronized in such a way that they would never transmit on the same frequency. While this only happens so infrequently that throughput is not substantially impacted, FCC rules do not allow this mode of operation. Other countries' rules do allow spread spectrum radios to be synchronized in time and frequency. If the co-located SEM masters are deployed in such a country, the **fcc disable** command can be issued to allow synchronization in frequency. The co-locate SEM masters must have their sync ports connected for this to have any affect. The default is **fcc enabled**.

The parameter entered for **length** is the decimal value of the number of 625  $\mu$ sec ticks in the desired dwell time. A value of **24** (decimal) corresponds to a hop dwell time of 15 msec and is the default. **16** is the minimum value and **28** is the maximum value. The dwell time is changed to optimize the data throughput for a given installation.

**set** selects a limited frequency band to be used. The default value is 0 which uses the entire frequency. For operation in France use a value of 1. The SEM radio also has 5 additional hop sets that avoid 802.11b channels. This allows the SEM to operate in environments with an 802.11b network without interfering with the 802.11b network. The table below provides details of the hop sets.

Hop Set	Frequency Range	802.11b Channels Avoided
0	2401 – 2471MHz	None
1	2448 – 2473MHz (France)	1-6 & 14
2	2448 – 2473MHz	1-6 & 14
3	2471 – 2497MHz	1-10
4	2452-2477MHz	1-6 & 14
5	2401 – 2425MHz	6-14
6	2409 – 2435MHz	8-14
7	2419 – 2445MHz	1 & 10-14
8	2430 – 2455MHz	1, 2 & 11-14
9	2440 – 2465MHz	1-4 & 14

The frequency of the 802.11b channel avoided refers to the center frequency of the 802.11b channel.

**slave list** displays the serial numbers of the radios in the SEMs that are currently registered with the SEM. **disconnect** terminates the connection between the master SEM and the slave SEM with the radio serial identification number entered. The radio serial identification number must be entered with the “-“s and can be found using **list**.

**sync** These commands set the operation of the synchronization signal used in co-located SEM networks. The default mode is the sync OFF. Sync is enabled by selecting a synchronization **master**. Synchronization will occur over the RS-485 SYNC lines. One co-located master SEM must be configured as the sync master. If sync has been enabled, the other co-located master SEMs will listen for a sync signal from the sync master. If no sync is heard, a co-located master SEM will make itself a sync master and provide a sync signal. This is called the master backup override mode. **override** toggles the master backup override on and off. The default mode is ON. In standalone SEM installations, synchronization is not required and should be left disabled.

The following commands are issued by typing **radio** and then the subcommand followed by the subcommand parameters if any.

Command		Description
radio	help	Displays command list
	banner	Displays power on banner for the radio in the SEM
	defaults	Resets the radio parameters to the factory shipped values
	masterbw [ 10..80] (Master only)	Displays master to slave bandwidth in percentage Sets master to slave bandwidth in 10 percent increments between 10 and 80 percent. Remainder of bandwidth is shared among slaves for slave to master communication Default = 50
	maxslaves [ 0..15] (Master only)	Displays value currently in use Sets the maximum number of slaves the master will allow to register. Default = 15
	network [ 0..63]	Displays current SEM network number Sets the network number for the SEM Default = 0
	power [ low high]	Displays radio output setting: low = 10dBm; high=18dBm (Default) Sets radio output power
	show	Displays radio parameters that have been modified from factory settings
	spid [ 0..254]	Displays service provider ID Sets service provider ID Default = 0

- help** Displays list of sub-commands under the *radio* command.
- banner** Displays the power on banner of the radio inside the SEM.
- defaults** Replaces any modified parameters with the factory default values.
- masterbw** Sets the percentage of the total RF bandwidth to be allocated to the Master transmissions. Ranges from 80 percent to 10 percent in 10 percent increments. Default is 50 percent. The RF bandwidth not allocated to the Master transmissions is shared among the slave SEMs for transmissions to the Master.
- maxslaves** Sets a limit to the number of slaves SEMS that a master SEM can have registered simultaneously. The default is 15 but the parameter can range from 1 to 15. If

more than **maxslaves** slave SEMs attempt to connect to the access point, they will be denied access.

- network** The radio in the SEM has 64 preprogrammed hopping patterns or network numbers. By using different network numbers, nearby co-located networks can avoid interfering with each other's transmissions. Even if both networks tried to use the same frequency, on the next hop they would be at different frequencies. **nwt** can range from 0 to 63.
- power** This command sets the transmit output power level of the SEM radio. The default is 1 which corresponds to +18dBm or 65 milliWatts. The other setting is 0 which corresponds to +10dBm or 10 milliWatts. This command is useful in the European Union where the transmit power is limited to +20dBm including antenna gain. Setting the transmit power to +10dBm allows up to 10dBi of antenna gain to be used.
- show** This command displays a list of the current radio parameters including the network number, maxremotes and the sys outmax value.
- spid** The SEM has 64 different network numbers (hopping patterns) allowing multiple networks of SEMs to be co-located while keep the networks segregated. In some situations, particularly in outdoor deployments, there may be other entities using SEMs. In most cases, the network number will be sufficient to keep the networks separate. However, it may not be possible to coordinate network numbers with an unknown third party. In this instance, the service provider ID or **spid** provides an additional 255 codes to distinguish networks. This feature is particularly useful if the slave SEMs are setup to connect to the first master they hear. While they can link with a SEM with any network number, they cannot link with a SEM with the wrong **spid**.

## Specifications

Model	SEM2410	SEM2410X	SEM2410D	SEM2410DX
Data Throughput	200Kbps full duplex point to point			
Total over-the-air bandwidth	460.8Kbps			
Network Interface	10/100BaseT Auto-sensing			
SEM Network Topologies	Point-to-Point and Multipoint			
RF Output Power	+10dBm/+18dBm Software Selectable			
RF Modulation	Frequency hopping, up to 64 user selectable hopping patterns			
Frequency Range	2400MHz to 2483.5MHz			
Operating Voltage Range	+9Vdc to +30Vdc	+12Vdc to +30Vdc	+9Vdc to +30Vdc	+12Vdc to +30Vdc
Enclosure	Aluminum	Aluminum (network interface unit) UV stabilized polycarbonate (remote radio unit)	ABS	ABS (network interface unit) UV stabilized polycarbonate (remote radio unit)
Dimensions	201x144 x53mm	201x144x53 mm (network interface unit) 130x79x35 (remote radio unit)	140x118 x48mm	140x118x48 mm (network interface unit) 130x79x35 (remote radio unit)
Operating Temperature	-30°C to +70°C	-30°C to +70°C (remote radio unit) -40°C to +70°C	-30°C to +70°C	-30°C to +70°C (remote radio unit) -40°C to +70°C
Humidity	0 to 95% humidity, non-condensing			
Licensing	Type certified for Worldwide License-free operation under FCC Part 15.247 and EN300328			

### Connectors

Power	2-Pin DIN
Ethernet	RJ-45
Console Port	RJ-11
Antenna	Reverse TNC Male
Sync (2)	RJ-11
Remote Radio (SEM2410X/DX only)	DB-15 (SEM2410X) Phoenix 16pin (SEM2410DX)

### Indicators

Power
Ethernet Transmit Data
Ethernet Receive Data
Ethernet Link Status
RF Link Status
RF Transceiver OK (SEM2410X/DX only)

## Troubleshooting

### **Ethernet Link LED is not on.**

Check the power LED on the SEM. Check the Ethernet cable, making sure that it is fully connected. Check the gender of the Ethernet cable. The SEM can drive CAT5 cable to a maximum length of 100 meters. If a longer cable length is needed a signal regenerating device must be placed in line.

### **Cannot telnet to SEM.**

Check the power LED on the SEM. Check the Ethernet cable, making sure that it is fully connected. Make sure the SEM has a valid, unique IP number on the network. If you are attempting to telnet to the SEM through a router, make sure that the correct address has been entered in the routing table. If the telnet security is enabled, make sure a device with an IP address on the allowed list is being used to initiate the telnet session.

### **The SEM does not respond through the Console Port.**

Check that a straight through serial cable is being used if connected to a PC. If you are not using WinSEM24, verify that the host serial port is set for 38.4Kbps, 8 data bits, 1 stop bit and no parity. If you are using a terminal program, make sure that it is set up to transmit carriage returns when entered from the keyboard. If the console security feature is enabled, the correct password must be entered at the prompt to gain access to the SEM command line.

### **Bridges do not link (RF Link LED is not on).**

Check that one bridge is configured as a master. Also check that the bridges are set to the same network number.

### **Technical Support**

Technical Support is available from Cirronet from 8:30am to 5:30pm Eastern Time, Monday through Friday. Contact Technical Support at (678) 684-2000 or by email at [tech\\_sup@cirronet.com](mailto:tech_sup@cirronet.com).

## Warranty

Seller warrants solely to Buyer that the goods delivered hereunder shall be free from defects in materials and workmanship, when given normal, proper and intended usage, for twelve (12) months from the date of delivery to Buyer. Seller agrees to repair or replace at its option and without cost to Buyer all defective goods sold hereunder, provided that Buyer has given Seller written notice of such warranty claim within such warranty period. All goods returned to Seller for repair or replacement must be sent freight prepaid to Seller's plant, provided that Buyer first obtain from Seller a Return Goods Authorization before any such return. Seller shall have no obligation to make repairs or replacements which are required by normal wear and tear, or which result, in whole or in part, from catastrophe, fault or negligence of Buyer, or from improper or unauthorized use of the goods, or use of the goods in a manner for which they are not designed, or by causes external to the goods such as, but not limited to, power failure. No suit or action shall be brought against Seller more than twelve (12) months after the related cause of action has occurred. Buyer has not relied and shall not rely on any oral representation regarding the goods sold hereunder, and any oral representation shall not bind Seller and shall not be a part of any warranty.

**THE PROVISIONS OF THE FOREGOING WARRANTY ARE IN LIEU OF ANY OTHER WARRANTY, WHETHER EXPRESS OR IMPLIED, WRITTEN OR ORAL (INCLUDING ANY WARRANTY OR MERCHANT ABILITY OR FITNESS FOR A PARTICULAR PURPOSE). SELLER'S LIABILITY ARISING OUT OF THE MANUFACTURE, SALE OR SUPPLYING OF THE GOODS OR THEIR USE OR DISPOSITION, WHETHER BASED UPON WARRANTY, CONTRACT, TORT OR OTHERWISE, SHALL NOT EXCEED THE ACTUAL PURCHASE PRICE PAID BY BUYER FOR THE GOODS. IN NO EVENT SHALL SELLER BE LIABLE TO BUYER OR ANY OTHER PERSON OR ENTITY FOR SPECIAL, INCIDENTAL OR CONSEQUENTIAL DAMAGES, INCLUDING, BUT NOT LIMITED TO, LOSS OF PROFITS, LOSS OF DATA OR LOSS OF USE DAMAGES ARISING OUT OF THE MANUFACTURE, SALE OR SUPPLYING OF THE GOODS. THE FOREGOING WARRANTY EXTENDS TO BUYER ONLY AND SHALL NOT BE APPLICABLE TO ANY OTHER PERSON OR ENTITY INCLUDING, WITHOUT LIMITATION, CUSTOMERS OF BUYERS.**